

*The Industrial Ethernet Cable Guide
for Petrol Forecourt Installations*



Industrial Ethernet Petrol Forecourt Cable (Solid) 3014P24S1001

Industrial Ethernet Petrol Forecourt Cable (Solid) 3014P24S1001-10

Cable excellence engineered through quality



Industrial Ethernet OPT cable manufactured for Petrol Forecourt Applications.

The Galvanised steel wire braid and overall polyurethane sheath make for a rugged cable with excellent resistance to oil and petrol. Tested to BS EN13617-1:2004. Safety requirements for construction and performance of metering pumps, dispensers and remote pumping units Section 5.3.2.4 cables used in hazardous areas, independently tested by Sira. As directed by the IP/APEA Hazardous Area "Blue Book".



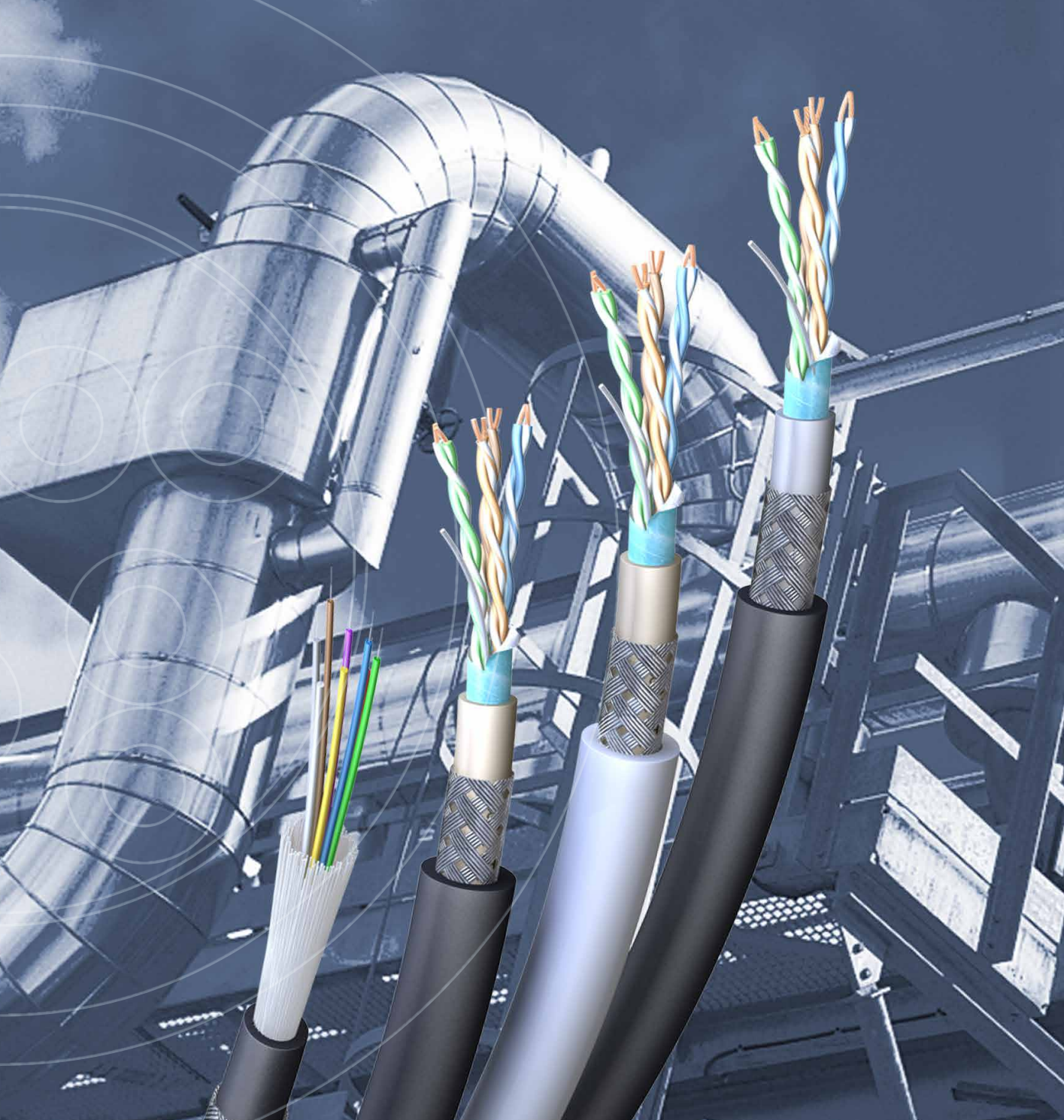

Characteristics

- Flame Retardant
- Flexible Installation
- Permanent Installation
- Outdoor Cable
- Silicon Free
- Sunlight Resistant
- Oil Resistant
- Cold Resistant

Industrial Ethernet OPT Cable (solid) Black

Part Number : 3014P24S1001

Cross Section

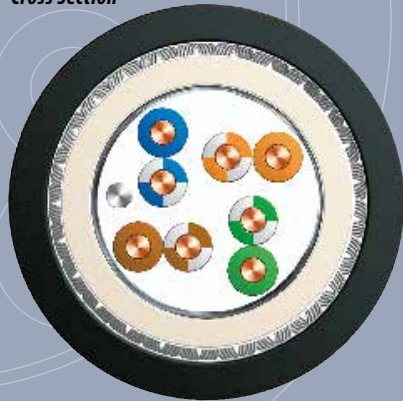

Cable Construction

1	Conductor	Solid bare copper wire (24awg) Ø 0.500 mm
2	Insulation	Polyethylene (PE) Ø 0.95 mm
3	Drain Wire	Tinned copper
4	Screen	Aluminium/polyester tape
5	Inner Jacket	LSZH FireFighter™ Ø 5.75 mm
6	Armour	DataGuard™ Galvanised Steel wire braid
7	Outer Jacket	Polyurethane (PUR) Black, Ø 9.75 mm

Table 21 Test Voltage of Core

Type	Test Voltage
321, 331	7500V 5 mins
Additional Test	12000V 1 min

Tested to BS EN13617-1:2004. Safety requirements for construction and performance of metering pumps, dispensers and remote pumping units section 5.3.2.4 cables used in hazardous areas, independently tested by Sira. As directed by the IP/APEA Hazardous Area "Blue Book".

Additional voltage test to BS6708 table 21, types 321 and 331

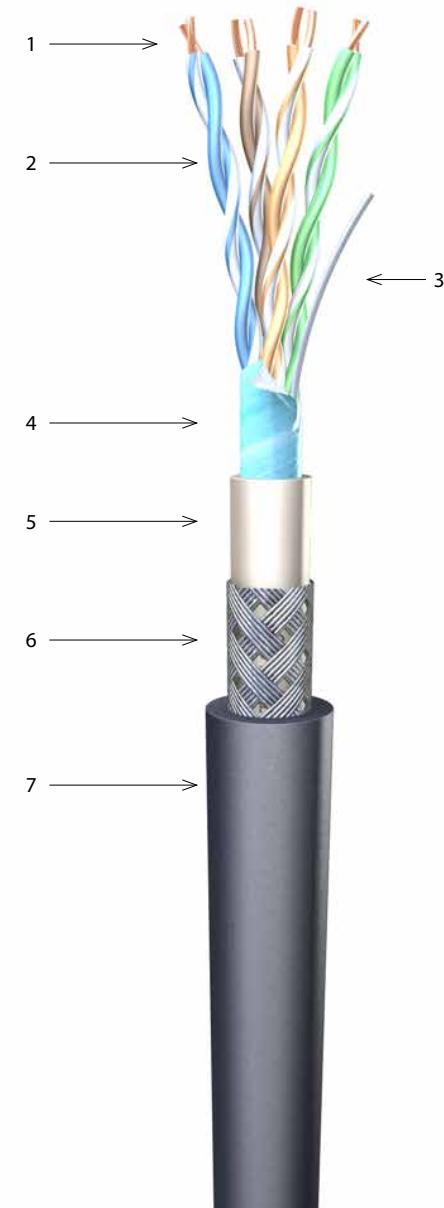

Electrical & Mechanical Characteristics

Conductor loop resistance max.	Insulation resistance min.	Characteristic impedance 1-100 MHz	Transfer impedance max. 10 MHz	Mutual capacitance nom.	Relative propagation velocity ca.	Screening attenuation min. ≤ 100 MHz	Test voltage
Ω/100m	GΩ x km	Ω	mΩ/m (nom.)	nF/km	c	dB	V-AC
19	5	100±15	30	50	0,74	40	700

Temperature Range

during installation -15 to +70°C	stationary -40 to +70°C
-------------------------------------	----------------------------

Frequency (MHz)	Attenuation (dB/100m)	NEXT (dB)	ACR (dB/100m)	ELFEXT (dB/100m)	RL (dB)
	Nom.	Nom.	Nom.	Nom.	Nom.
1	1,9	80	78,1	68	24
4	3,7	75	71,3	56	30
10	5,6	70	64,4	46	34
16	7,2	68	60,8	43	35
20	7,9	65	57,1	41	34
31,25	10,3	60	49,7	36	33
62,5	14,4	56	41,6	32	31
100	18,2	50	31,8	26	28
155	19,9	45	25,1	24	26
200	24,2	42	17,8	22	24

Industrial Ethernet OPT Cable (solid) White

Part Number : 3014P24S1001-10

Cross Section

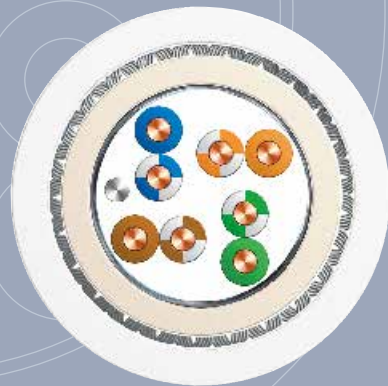

Cable Construction

1	Conductor	Solid bare copper wire (24awg) Ø 0.500 mm
2	Insulation	Polyethylene (PE) Ø 0.95 mm
3	Drain Wire	Tinned copper
4	Screen	Aluminium/polyester tape
5	Inner Jacket	LSZH FireFighter™ Ø 5.75 mm
6	Armour	DataGuard™ Galvanised Steel wire braid
7	Outer Jacket	Polyurethane (PUR) White, Ø 9.75 mm

Table 21 Test Voltage of Core

Type	Test Voltage
321, 331	7500V 5 mins
Additional Test	12000V 1 min

Tested to BS EN13617-1:2004. Safety requirements for construction and performance of metering pumps, dispensers and remote pumping units section 5.3.2.4 cables used in hazardous areas, independently tested by Sira. As directed by the IP/APEA Hazardous Area "Blue Book".

Additional voltage test to BS6708 table 21, types 321 and 331

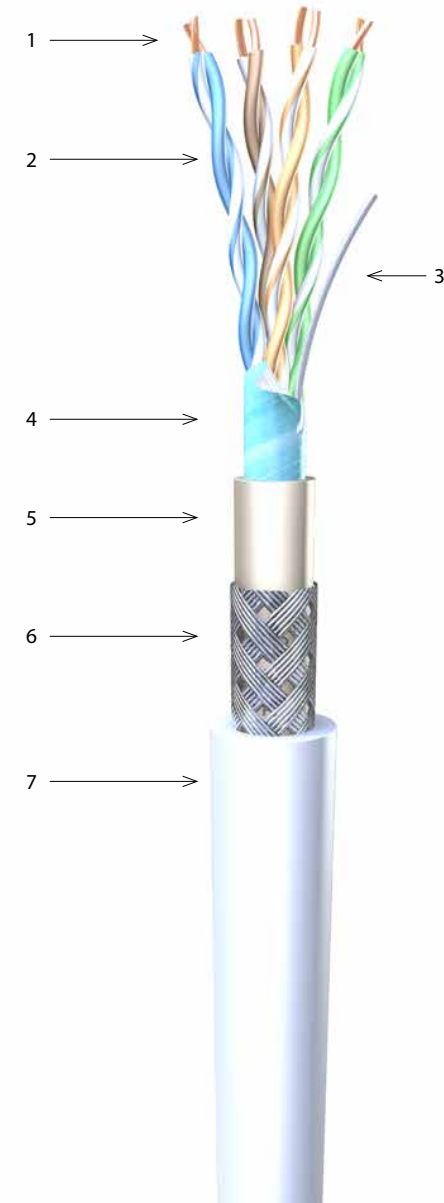

Electrical & Mechanical Characteristics

Conductor loop resistance max.	Insulation resistance min.	Characteristic impedance 1-100 MHz	Transfer impedance max. 10 MHz	Mutual capacitance nom.	Relative propagation velocity ca.	Screening attenuation min. ≤ 100 MHz	Test voltage
Ω/100m	GΩ x km	Ω	mΩ/m (nom.)	nF/km	c	dB	V-AC
19	5	100±15	30	50	0,74	40	700

Temperature Range

during installation -15 to +70°C	stationary -40 to +70°C
-------------------------------------	----------------------------

Frequency (MHz)	Attenuation (dB/100m)	NEXT (dB)	ACR (dB/100m)	ELFEXT (dB/100m)	RL (dB)
	Nom.	Nom.	Nom.	Nom.	Nom.
1	1,9	80	78,1	68	24
4	3,7	75	71,3	56	30
10	5,6	70	64,4	46	34
16	7,2	68	60,8	43	35
20	7,9	65	57,1	41	34
31,25	10,3	60	49,7	36	33
62,5	14,4	56	41,6	32	31
100	18,2	50	31,8	26	28
155	19,9	45	25,1	24	26
200	24,2	42	17,8	22	24

* Category 5 acc. to IEC 61156-5 | ** For information only

Industrial Ethernet OPT Cable (stranded) Black

Part Number : 3014P252626

Cross Section



Cable Construction

1	Conductor	Stranded bare copper wire (26awg) 7x0.162 mm
2	Insulation	Polyethylene (PE) Ø 0.88 mm
3	Drain Wire	Stranded tinned copper, 7x0.162 mm
4	Screen	Aluminium/polyester tape
5	Inner Jacket	LSZH FireFighter™ Ø 5.60 mm
6	Armour	DataGuard™ Galvanised Steel wire braid
7	Outer Jacket	Polyurethane (PUR) Black, Ø 9.20 ± 0.8 mm

Table 21 Test Voltage of Core

Type	Test Voltage
321, 331	7500V 5 mins
Additional Test	12000V 1 min

Tested to BS EN13617-1:2004. Safety requirements for construction and performance of metering pumps, dispensers and remote pumping units section 5.3.2.4 cables used in hazardous areas, independently tested by Sira. As directed by the IP/APEA Hazardous Area "Blue Book".

Additional voltage test to BS6708 table 21, types 321 and 331

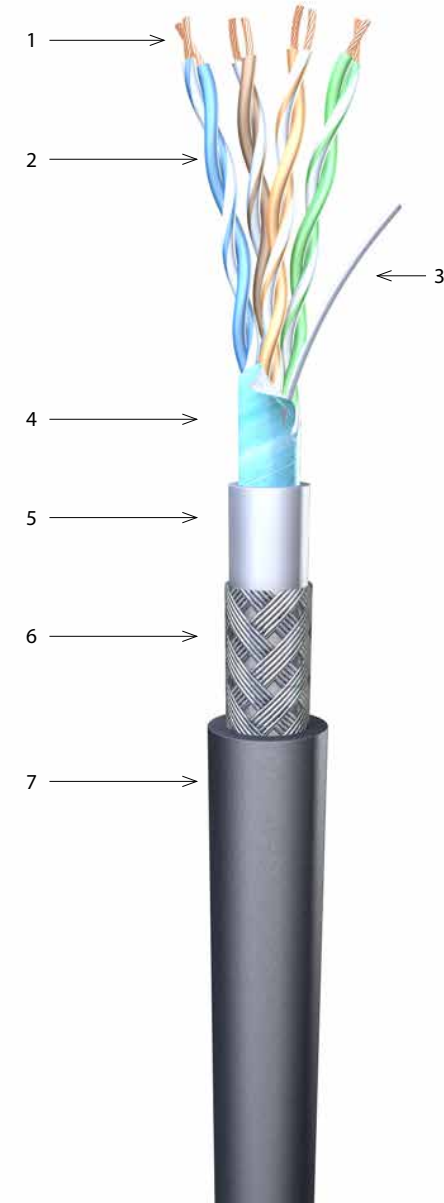

Electrical Characteristics

Conductor resistance	Min. Insulation resistance	Characteristic impedance 1-100 MHz	Rated voltage	Rated Temperature
$\Omega/100m$	M Ω .km	Ω	V	$^{\circ}C$
≤ 14.94	≥ 200	100 ± 2	150	80

Frequency (MHz)	Attenuation (dB) $\pm 15\%$	Return Loss (dB) (min)	Next Worst Pair (dB) (min)
1	3.1	17	62.3
4	6.1	18.8	53.3
8	8.6	19.7	48.8
10	9.7	20	47.3
16	12.4	20	44.3
20	13.9	20	42.8
25	15.6	19.3	41.3
32.25	17.6	18.6	39.9
62.5	25.5	16.5	35.4
100	33	15.1	32.3

Fibre Optic 'FT Type' Distribution Cable 8core 62.5/125 Black

Part Number : 301101084

Cable Construction

1	Tight coating	900 ± 50 µm tight buffered optical fibre
2	Colour Code	to IEC 60304
3	Strength member	Glass fibre yarns (swellable for longitudinal watertightness)
4	Rip cord	1 x under jacket
5	Inner Jacket	LSZH FireFighter™ Ø 6.50 mm
6	Armour	DataGuard™ Galvanised Steel wire braid
7	Outer Jacket	Polyurethane (PUR) Black, Ø 9.47 mm

Table 21 Test Voltage of Core

Type	Test Voltage
321, 331	7500V 5 mins
Additional Test	12000V 1 min

Tested to BS EN13617-1:2004. Safety requirements for construction and performance of metering pumps, dispensers and remote pumping units section 5.3.2.4 cables used in hazardous areas, independently tested by Sira. As directed by the IP/APEA Hazardous Area "Blue Book".

Additional voltage test to BS6708 table 21, types 321 and 331

Cross Section

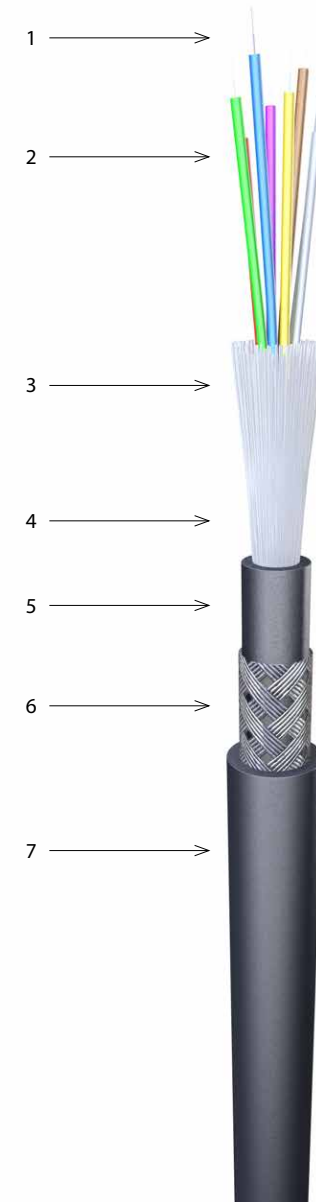

Optical Characteristics

62.5/125 OM1 multi-mode graded-index optical fibres acc. to IEC 60793

Fibre Type	Mode-Field Diameter (µm)	Wavelength (nm)	Attenuation average/max. (dB/km)	Bandwidth (MHz·km)	Ethernet Performance (m)		Num. Aperture (µm)	Refr. Index
					1 GBE	10 GBE		
62.5/125 OM1	62.5 ± 2.5	850	2.7 / 3.2	≥ 200	275	33	0.275 ± 0.015	1.495
	125 ± 1	1300	0.6 / 1.1	≥ 600	550	n.a		1.490

Bending Radius (min.)		Crush resistance N/10cm	Impact resistance w/20N.m	Temperature Range		
long term	short term			Storage (°C)	Installation (°C)	Operating (°C)
15 x Ø (no load)	25 x Ø (load)	2000	3 impacts	-40°C to +60°C	-5°C to +40°C	-20°C to +50°C

Fibre Optic 'FT Type' Distribution Cable 8core 62.5/125 White

Part Number :

Cable Construction

1	Tight coating	900 ± 50 µm tight buffered optical fibre
2	Colour Code	to IEC 60304
3	Strength member	Glass fibre yarns (swellable for longitudinal watertightness)
4	Rip cord	1 x under jacket
5	Inner Jacket	LSZH FireFighter™ Ø 6.50 mm
6	Armour	DataGuard™ Galvanised Steel wire braid
7	Outer Jacket	Polyurethane (PUR) White, Ø 9.47 mm

Table 21 Test Voltage of Core

Type	Test Voltage
321, 331	7500V 5 mins
Additional Test	12000V 1 min

Tested to BS EN13617-1:2004. Safety requirements for construction and performance of metering pumps, dispensers and remote pumping units section 5.3.2.4 cables used in hazardous areas, independently tested by Sira. As directed by the IP/APEA Hazardous Area "Blue Book".

Additional voltage test to BS6708 table 21, types 321 and 331

Cross Section

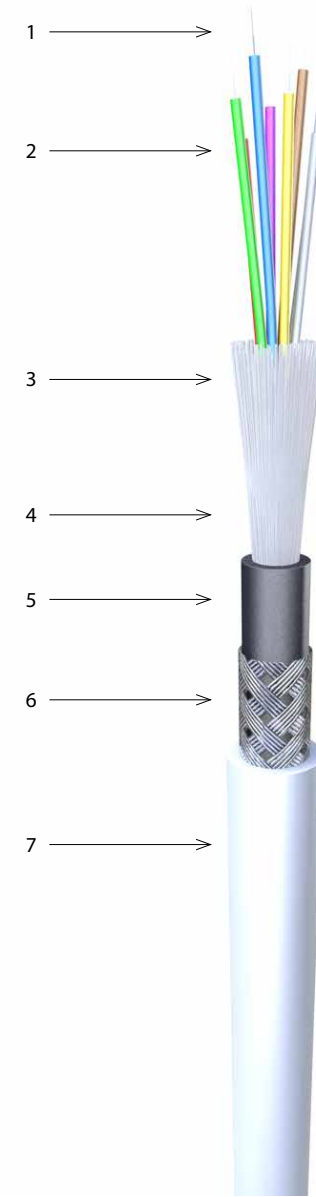

Optical Characteristics

62.5/125 OM1 multi-mode graded-index optical fibres acc. to IEC 60793

Fibre Type	Mode-Field Diameter (µm)	Wavelength (nm)	Attenuation average/max. (dB/km)	Bandwidth (MHz·km)	Ethernet Performance (m)		Num. Aperture (µm)	Refr. Index
					1 GBE	10 GBE		
62.5/125 OM1	62.5 ± 2.5	850	2.7 / 3.2	≥ 200	275	33	0.275 ± 0.015	1.495
	125 ± 1	1300	0.6 / 1.1	≥ 600	550	n.a		1.490

Bending Radius (min.)		Crush resistance N/10cm	Impact resistance w/20N.m	Temperature Range		
long term	short term			Storage (°C)	Installation (°C)	Operating (°C)
15 x Ø (no load)	25 x Ø (load)	2000	3 impacts	-40°C to +60°C	-5°C to +40°C	-20°C to +50°C

EMV Gland for Industrial Ethernet OPT Cable

Part Number : 50.620 M/EMV/EX

The EMV ATEX cable gland specifically for use with the Industrial Ethernet OPT cable. The simple construction and assembly method allow for easier site installation whilst maintaining excellent equipotential bonding characteristics of the braid armour without compromising the increased safety demands of the EEx e standard.

Characteristics

- Easier Installation
- IP68 Protection
- ATEX Approved
- Increased Safety EEx e
- Metric thread as per EN60423

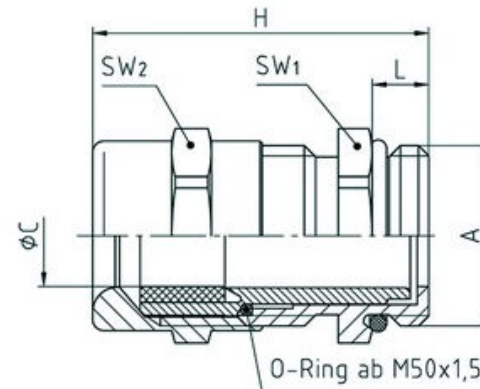

Configuration

Dome Nut :	Brass CuZn39Pb3, nickel-plated.
Dust cap :	Polyethylene PE-HD.
Lamellar inset :	Polyamide PA6 C-2.
Sealing ring :	Polychloroprene-Nitrile rubber CR/NBR.
Gland body :	Brass CuZn39Pb3, nickel-plated.
O-ring :	Nitrile rubber NBR
Connecting thread :	as per EN 60423

Properties

For cables with shielding, intergrated anchorage, wide sealing and clamping range.

Equipment group :	II
Category / Zone :	2G and 2D / 1, 2, 21, 22
Type of protection :	EEx e , Increased safety
Temperature range :	-20°C to +80°C
Protection grade :	IP68 - 5 bar
Cable installation :	Flexible
Test standard :	EN 50014 / EN 50019
EC-Type certification :	DMT 99 ATEX E016

Part Number	A	Ø C	L	SW1	SW2	H	VPE
		mm	mm	mm	mm	mm	
50.620 M/EMV/EX	M20x1.5	9-13	6	22	22	36	100



CSA Group – Providing Sira Certification and CSA Approvals

Configuration

Hexagonal Locknut : Brass CuZn39Pb3, nickel-plated.

Internal thread : metric as per EN 60423.

Properties

With cutting edges : To secure tightening of EMC-cable glands, to cut through paint layers or powder coatings ensuring optimal contact for equipotential bonding, increased vibration resistance.

Temperature Range : 60°C up to +200°C.

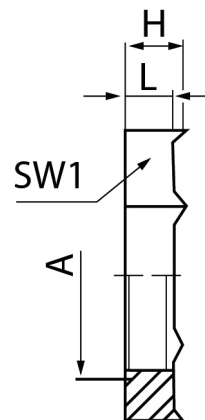

Part Number	A	L	SW1	H	VPE
50.620 M/EMVLEX	M20x1.5	4.5 mm	24 mm	5.5 mm	100

EMV Gland for Industrial Ethernet OPT Cable

Part Number : 50.620 M/EMVLEX

The EMV ATEX cable gland specifically for use with the Industrial Ethernet OPT cable. The simple construction and assembly method allow for easier site installation whilst maintaining excellent equipotential bonding characteristics of the braid armour without compromising the increased safety demands of the EEx e standard.

Characteristics

- Easier Installation
- IP68 Protection
- ATEX Approved
- Increased Safety EEx e
- Metric thread as per EN60423





Belcom Cables Ltd

Green Street
Elsenham
Essex
CM22 6DS

Tel: 01279 871150

Fax: 01279 871129

E-mail: sales@belcom.co.uk

Website: www.belcom.co.uk